

**P/N: 24HST1041E-2 DATA SHEET****Feature**

- Designed for long haul gigabit Ethernet 1000 BASE-T, full duplex applications.
- Supports 4 pairs of category 5 UTP cable.
- Cable interface for isolation and low common mode emissions.
- Compliant with IEEE 802.3ab standard for 1000 BASE-T.
- Operating temperature range: 0°C to +70°C.
- Storage temperature range: -25°C to +125°C.

Electrical Specifications @ 25°C

Part Number	Turns Ratio (±5%)		OCL (uH Min) @100KHz/0.1V with 8mA DC Bias	Cross talk Attenuation (dB Min)			HI-POT (Vrms)
	TX	RX		30MHz	60MHz	100MHz	
24HST1041E-2	1CT:1CT	1CT:1CT	350	-45	-40	-35	1500

Continue

Part Number	Insertion Loss (dB Max)	Return Loss (dB Min)@Load 100Ω					DCMR (dB Min)		
		1-100MHz	1-30MHz	40MHz	50MHz	60-80MHz	100MHz	30MHz	60MHz
24HST1041E-2	-1.0	-18	-14.4	-13.1	-12	-10	-43	-37	-33

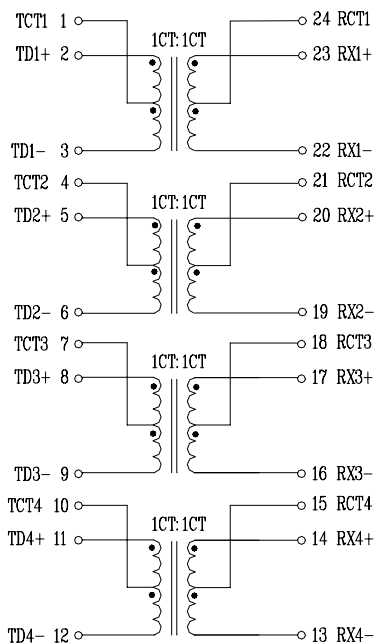
Schematic**Mechanical**