

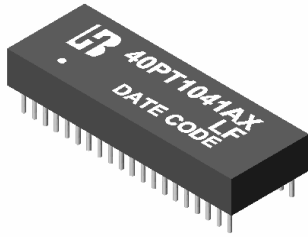

### 40 PIN DIP ETHERNET 10/100 BASE –TX HIGH SPEED LAN MAGNETICS

#### P/N: 40PT1041AX LF DATA SHEET

#### Feature



- Compliant with IEEE 802.3 E and ANSI X3.263 standards including 350uH OCL with 8mA Bias.
- Symmetrical TX and RX channels for Auto MDI/MDIX capability.
- Comply with RoHS requirements-whole part No Cd, No Hg, No Cr6+, No PBB and PBDE and No Pb on external pins.
- Operating temperature range : 0 to +70 .
- Storage temperature range: -25 to +105 .

#### Electrical Specifications @ 25° C

Part Number	Turns Ratio (±5%)		OCL (uH Min) @100KHz/0.1V with 8mA DC Bias	L.L (uH Max)	C <sub>www</sub> (pF Max)	HI-POT (Vrms)
	TX	RX				
40PT1041AX LF	1CT:1CT	1CT:1CT	350	0.4	56	1500

#### Continue

Part Number	Insertion Loss (dB Max)	Return Loss (dB Min)			Cross talk (dB Min)	DCMR (dB Min)
		0.3-30MHz	30-60MHz	60-80MHz		
40PT1041AX LF	-1.15	-16	-12	-10	-35	-30

#### Schematic

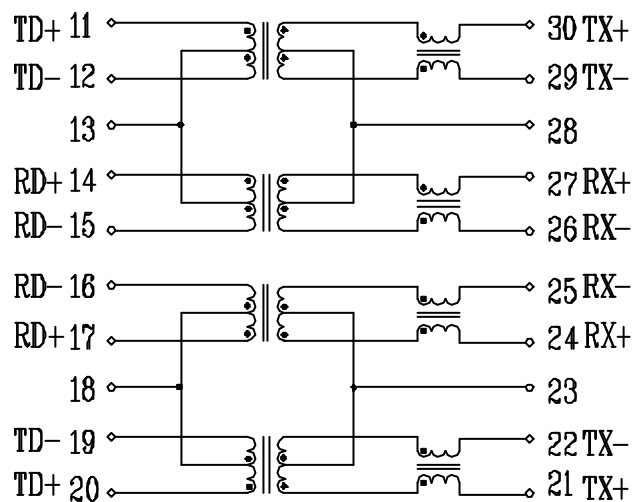
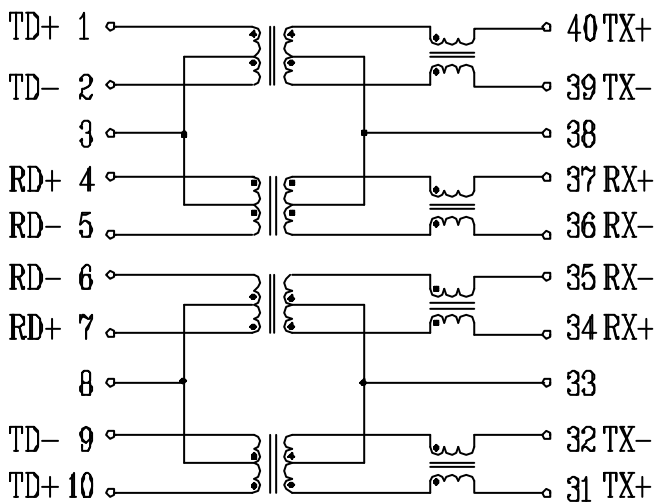



**40 PIN DIP ETHERNET 10/100 BASE –TX HIGH SPEED LAN MAGNETICS**

**P/N: 40PT1041AX LF DATA SHEET**

**Mechanical**

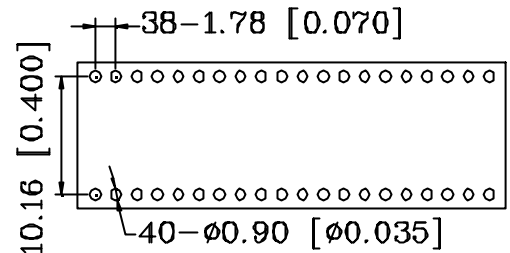
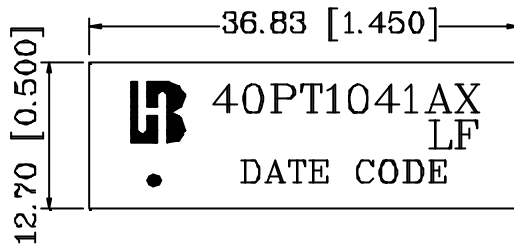

SUGGESTED PAD LAYOUT

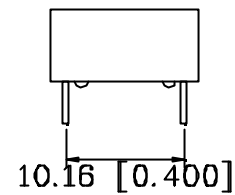
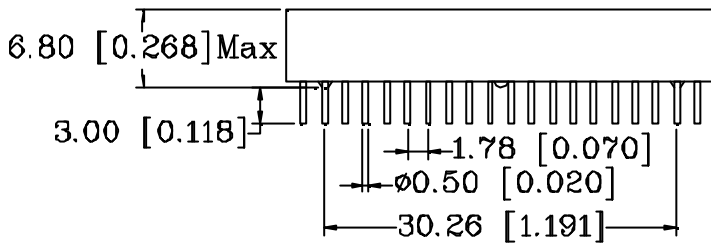

Units: mm[Inches] Tolerance: xx.x0±0.25[0.010]  
0.xx±0.05[0.002]